

Iris damper **GBL**



Description

The GBL iris dampers are essential for smooth control of the duct air pressure. The lever and the iris regulating plates mechanism allow smooth adjustment of the diameter of the orifice (opening). The iris-type closure allows throttling of the air flow without turbulence or in-duct noise. The GBL iris damper can be installed both in air supply and air exhaust ducts. Each Iris damper is provided with two manometer connections. The GBL can be opened to the full clear diameter for easier cleaning of the ductwork. The iris dampers, however, cannot be sealed shut (the maximum closing ratio is ca. 25% of the nominal clear diameter).

Available materials — Product code examples
GBL-... — galvanized steel sheet

Product code example

Product code: **GBL - aaa**

type _____
Ød₁ _____

Data for smoke restriction:

GBL-100 and GBL-125 meet the requirements of RakMK E7:2004 for dampers (42 dm³/s, 100Pa) when adjustment setting position is 4,5 or higher.

Dimensions

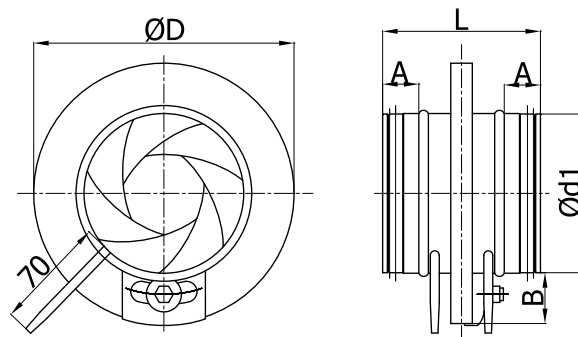

Ød _{1 nom} [mm]	ØD [mm]	L [mm]	A [mm]	B [mm]	Weight [kg]
80	125	120	35	22	0.5
100	165	110	30	32	0.5
125	188	110	30	32	0.7
150	230	110	30	40	1.3
160	230	110	30	35	0.9
200	285	110	30	42	1.4
250	335	135	40	42	2.1
315	410	135	40	47	3.5
400	525	150	50	62	6.4
500	655	150	50	77	9.6
630	815	150	50	92	15.6
800	1015	285	100	107	25.0

Technical specifications

K-value for various damper settings

Position	k							
	1	2	3	4	5	6	7	8
GBL 80	6.1	4.1	3.2	2.3	1.4	0.9	0.6	–
GBL 100	10.4	7.5	6.0	4.5	3.4	2.5	1.7	0.9
GBL 125	13.8	8.8	6.5	4.7	3.5	2.7	1.5	–
GBL 150	24.1	16.5	13.4	11.0	8.9	6.9	5.2	3.7
GBL 160	22.1	14.8	12.5	10.7	8.5	6.8	4.9	3.5
GBL 200	44.2	30.9	23.2	18.2	14.0	11.0	8.4	5.0
GBL 250	64.4	45.6	38.7	30.7	24.1	18.4	12.8	8.9
GBL 315	118.0	70.0	58.7	45.1	37.0	30.0	21.8	15.8
GBL 400	131.0	102.0	88.3	67.3	52.7	38.5	28.4	15.5
GBL 500	230.0	177.0	146.0	112.0	88.5	66.6	48.0	30.0
GBL 630	451.0	297.0	238.0	169.0	127.0	91.6	62.8	35.1
GBL 800	489.0	402.0	344.0	267.0	217.0	170.0	122.0	73.7

Technical specifications

GBL 80

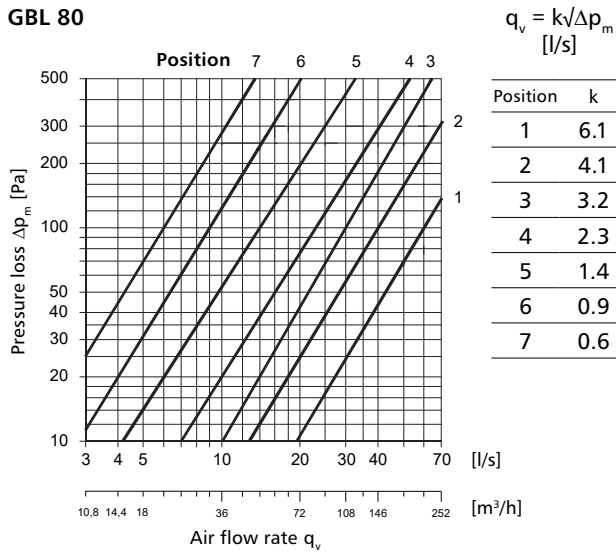

GBL 100

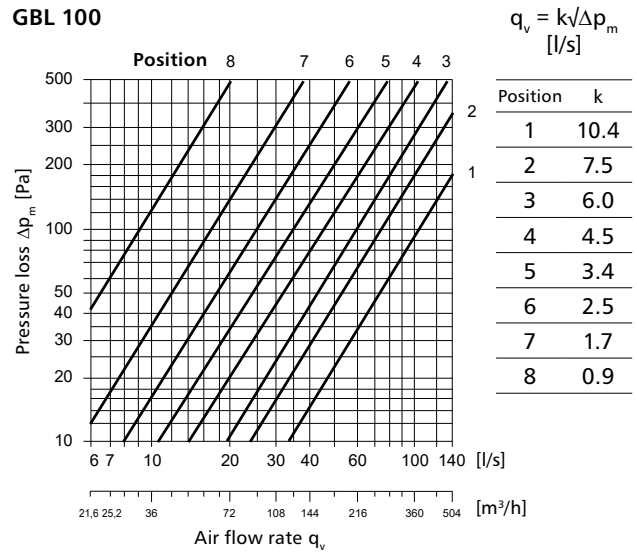

GBL 125

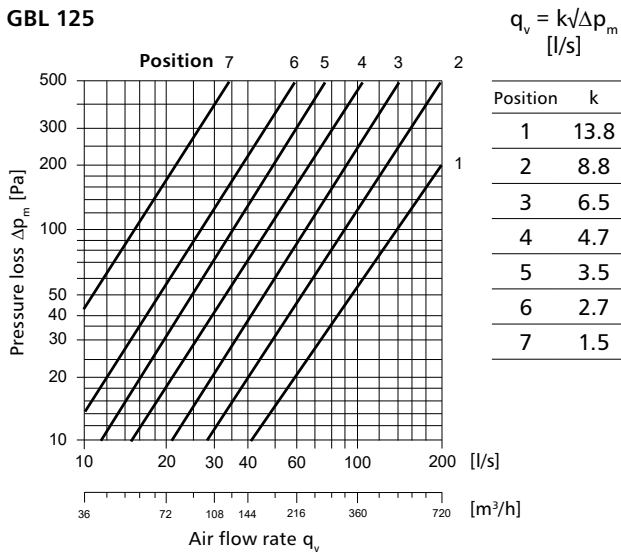

GBL 150

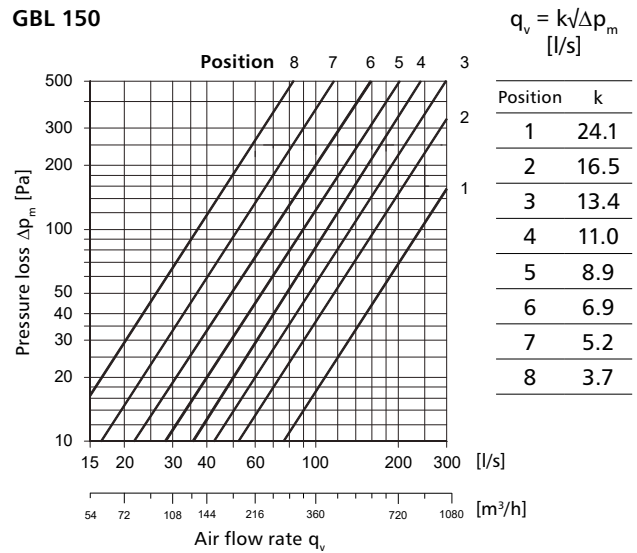

GBL 160

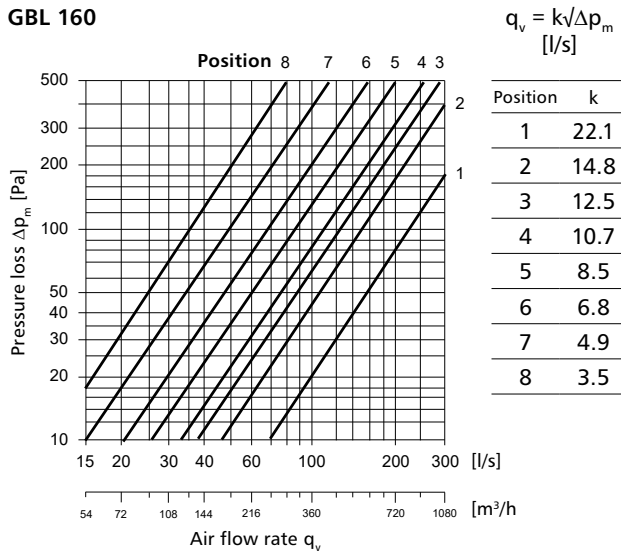

GBL 200

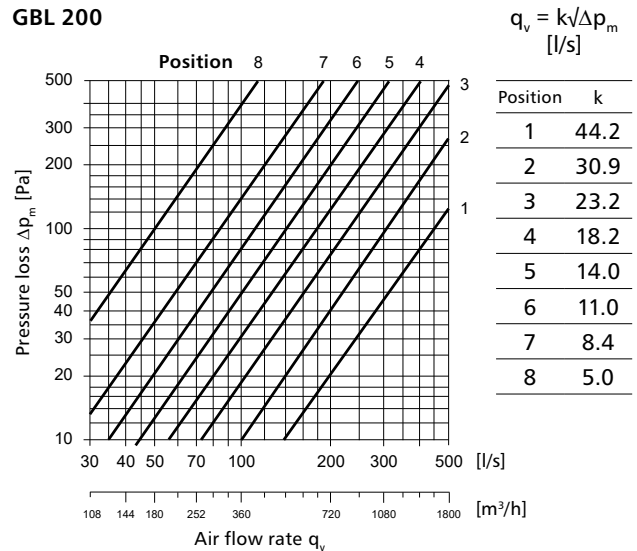

Iris damper GBL

Technical specifications

GBL 250

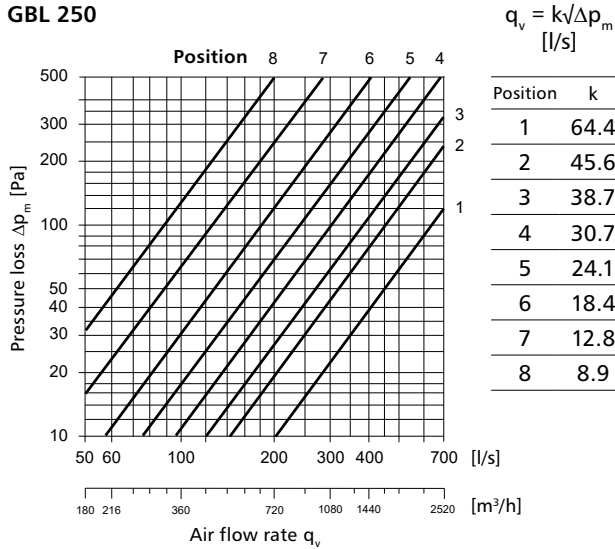

GBL 315

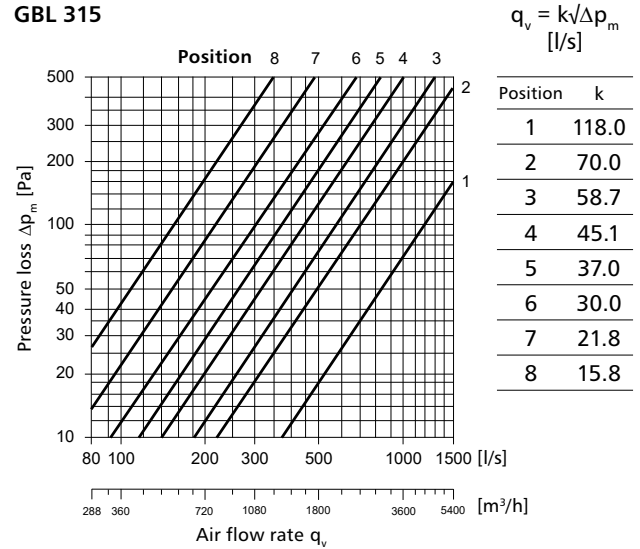

GBL 400

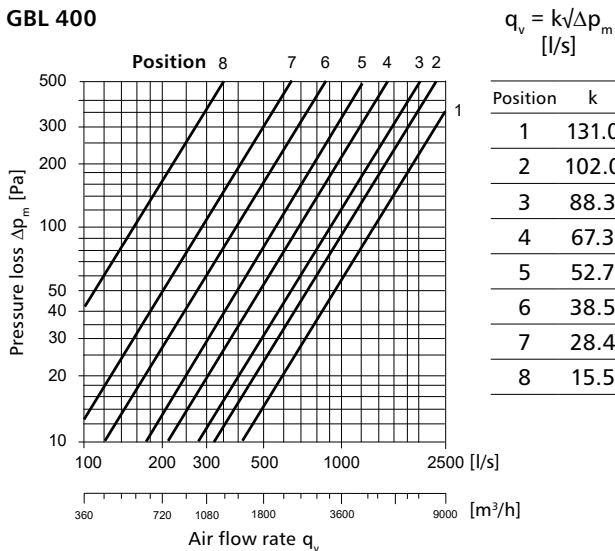

GBL 500

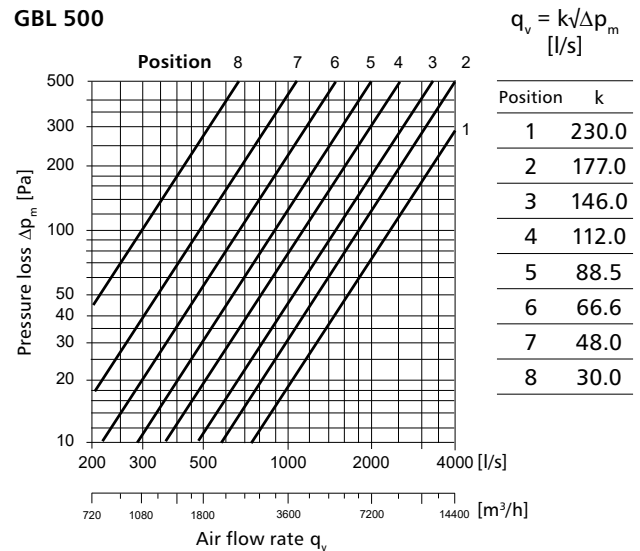

GBL 630

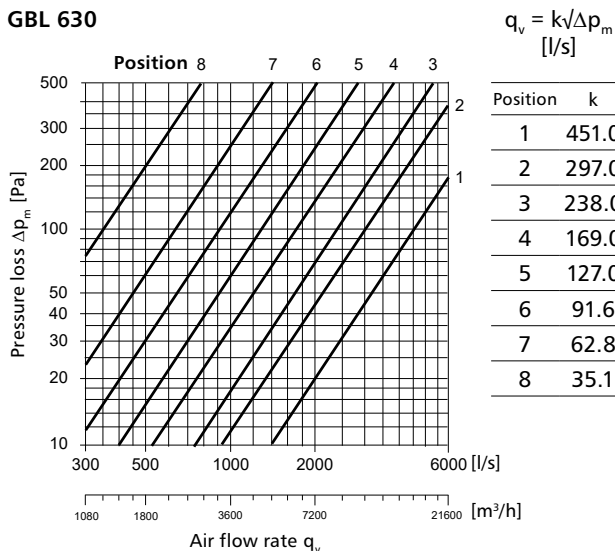

GBL 800

