

Regulating damper

DAR



Description

The DAR dampers for round ducts are available in the diameters of 80 mm to 630 mm. The damper closure has two chord-cut edges to provide 20% of the rated air flow in the closed position. The dampers 450 mm in diameter and larger have the damper closure pivot braced additionally with a single steel bar across the opening. The damper mechanism can be provided with up to 50 mm thick insulation and features a control dial to show the opening ratio. The dampers of diameter 450 mm or greater also feature the KIT-DS-H damper mechanism control lever for easier operation.

Available materials — Product code examples

DAR-... — galvanized steel sheet

DAR-K-... — 1.4301/304 stainless steel sheet

Product code example

Product code: **DAR - aaa**

type _____
 $\varnothing d_1$ _____

Dimensions

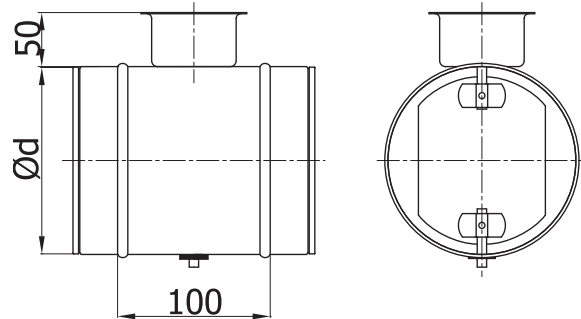

For $d_1 < 450$, the damper closure pivot is mounted on two short rods;

For $d_1 \geq 450$, the damper closure pivot is mounted on a single long bar.

$\varnothing d_{1, nom}$ (mm)	Weight (kg)
80	0.40
100	0.46
125	0.55
140	0.60
150	0.65
160	0.70
180	0.75
200	0.80
224	0.90
250	1.10
280	1.30
300	1.45
315	1.50
355	2.00
400	2.40
450	3.50
500	4.00
560	4.60
600	5.00
630	5.40

If the damper diameter is to be greater than 630 mm, order the DASQL multi-blade damper.

Regulating dampers

DARL/DAR/DARH

Technical specifications

Pressure loss and sound level charts to help with the product selection.

Solid lines show the overall pressure loss across a damper vs. the air flow rate and the damper closure opening angle. The curve shows the A-weighted sound level value, L_w (A), in dB, inside a connected duct.

Example:

Diameter \varnothing : 100
 Air flow rate: 60 l/s
 Pressure loss: 200 Pa

The following information can be read from the charts:

Opening angle: 40°
 Sound level: 62 dB(A)

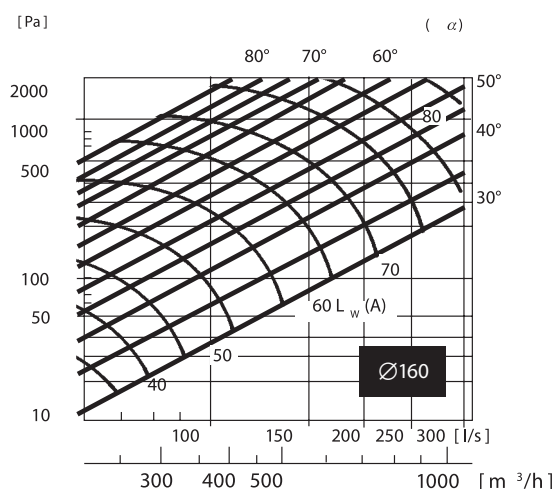
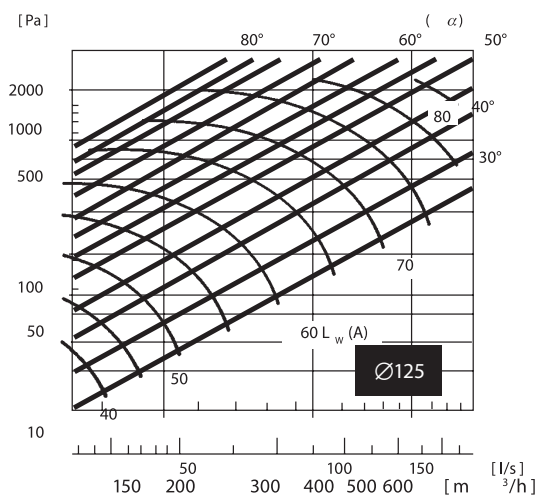
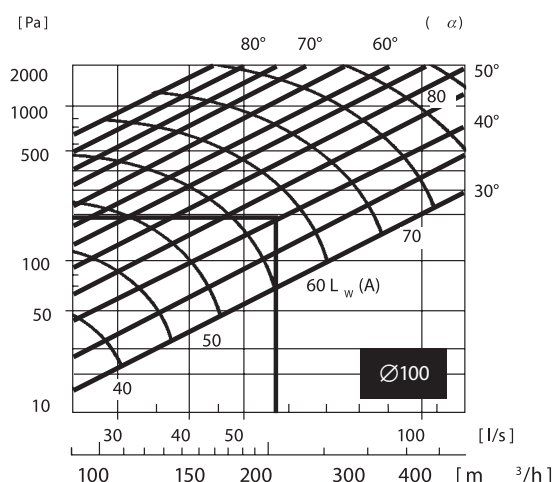
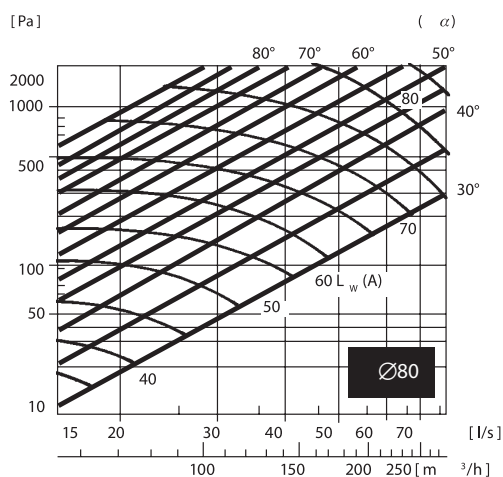

Regulating dampers

DARL/DAR/DARH

Technical specifications

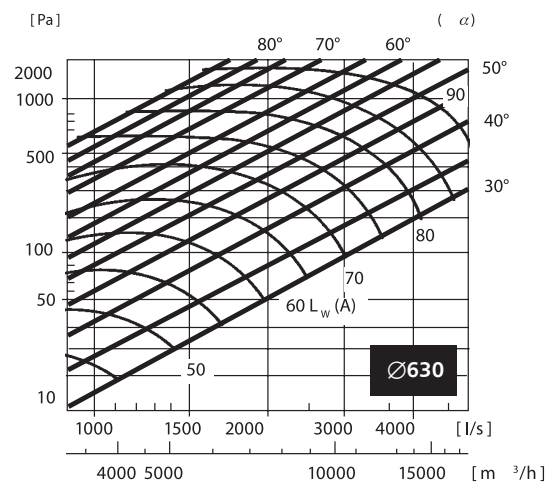
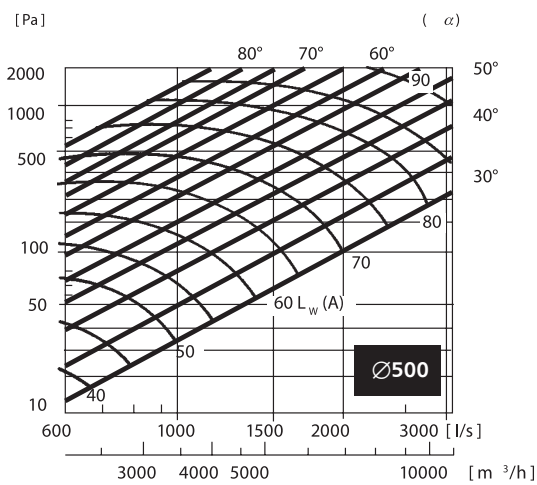
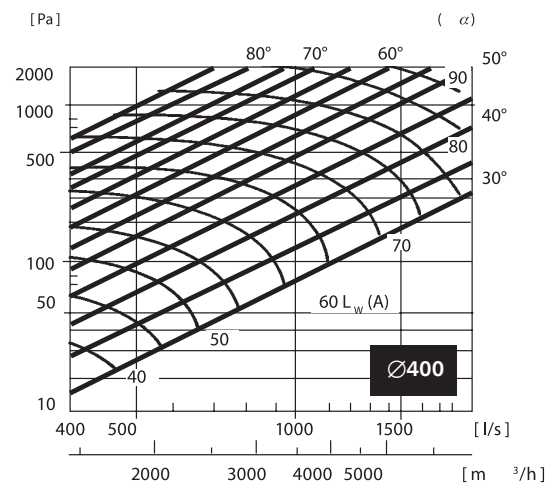
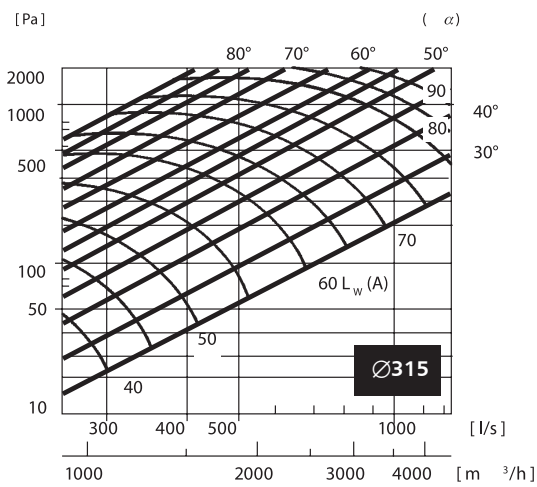
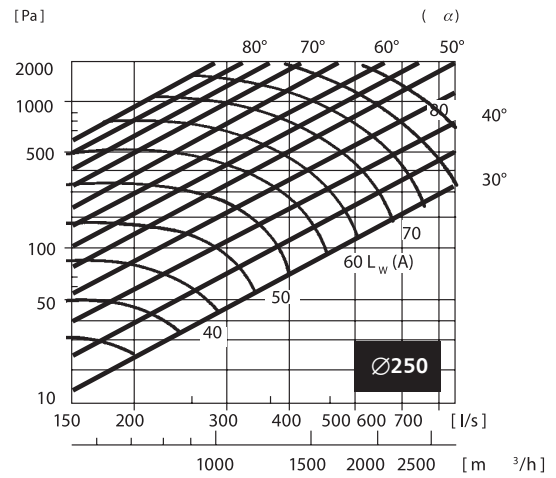
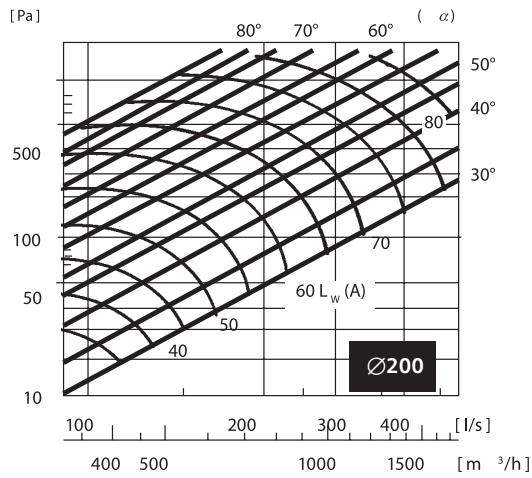

Regulating dampers

DARL/DAR/DARH

Technical specifications

Sound performance specifications for DARL dampers

Sound level L_w (dB) in 63-8000 Hz octave bands vs. diameter, air flow rate and pressure loss.

diameter (mm)	pressure loss (Pa)	mean velocity: 3 m/s frequency (Hz)								mean velocity: 6 m/s frequency (Hz)								mean velocity: 9 m/s frequency (Hz)								mean velocity: 12 m/s frequency (Hz)								mean velocity: 15 m/s frequency (Hz)							
		63	125	250	500	1k	2k	4k	8k	63	125	250	500	1k	2k	4k	8k	63	125	250	500	1k	2k	4k	8k	63	125	250	500	1k	2k	4k	8k	63	125	250	500	1k	2k	4k	8k
80		air flow rate: 15 l/s								air flow rate: 30 l/s								air flow rate: 45 l/s								air flow rate: 60 l/s								air flow rate: 75 l/s							
	500	65	65	65	65	59	55	49	46	67	67	67	67	60	57	50	47	70	70	70	70	63	60	53	49	75	75	75	75	68	64	56	53	80	80	80	80	72	68	60	56
	300	63	63	60	60	54	48	42	36	66	66	63	63	56	50	44	38	70	70	67	67	60	54	47	40	75	75	71	71	64	57	50	43	79	79	75	75	68	60	53	45
	200	63	63	60	54	51	43	34	29	65	65	62	56	53	44	35	30	70	70	67	60	57	48	38	32	75	75	71	65	61	51	41	34	-	-	-	-	-	-	-	-
	100	55	60	53	48	43	30	23	15	59	65	57	51	46	32	24	16	66	72	63	57	51	36	27	18	-	-	-	-	-	-	-	-	-	-	-	-	-	-	-	-
50	56	54	47	43	36	25	16	9	59	59	52	47	40	27	17	10	-	-	-	-	-	-	-	-	-	-	-	-	-	-	-	-	-	-	-	-	-	-	-	-	
100		air flow rate: 25 l/s								air flow rate: 50 l/s								air flow rate: 75 l/s								air flow rate: 100 l/s								air flow rate: 120 l/s							
	500	67	64	64	57	54	48	48	48	72	68	68	62	59	52	52	52	78	75	75	67	64	57	57	57	84	81	80	72	68	62	61	61	88	85	84	76	72	65	64	64
	300	62	61	60	54	51	45	42	42	68	68	68	59	56	50	47	47	75	74	73	65	61	54	51	51	81	80	79	70	67	59	56	55	86	85	84	74	70	62	59	58
	200	58	58	58	50	48	40	37	37	65	65	64	57	54	45	42	42	74	73	73	64	59	50	47	46	80	80	79	69	66	55	51	51	-	-	-	-	-	-	-	-
	100	58	55	53	46	41	34	26	24	68	66	62	54	48	40	31	29	79	75	71	62	56	46	36	33	-	-	-	-	-	-	-	-	-	-	-	-	-	-	-	-
50	55	53	48	42	35	26	22	18	69	67	60	53	44	33	28	22	-	-	-	-	-	-	-	-	-	-	-	-	-	-	-	-	-	-	-	-	-	-	-	-	
125		air flow rate: 40 l/s								air flow rate: 80 l/s								air flow rate: 120 l/s								air flow rate: 160 l/s								air flow rate: 180 l/s							
	500	71	68	65	59	56	50	50	47	76	73	70	63	60	53	53	50	83	79	76	68	65	58	58	54	89	85	81	73	69	62	62	58	91	87	83	75	71	63	63	59
	300	66	66	60	55	52	46	43	40	73	73	67	60	57	51	48	44	79	79	72	66	62	55	52	48	86	86	79	71	68	60	56	53	89	88	81	73	69	62	58	54
	200	65	62	57	51	46	41	38	38	74	71	65	59	53	47	43	43	82	78	71	65	58	51	48	48	89	85	78	70	63	56	52	52	-	-	-	-	-	-	-	-
	100	64	59	53	47	39	34	29	27	77	70	63	55	47	40	35	32	84	78	70	61	51	45	39	35	-	-	-	-	-	-	-	-	-	-	-	-	-	-	-	-
50	63	54	50	41	36	27	25	20	80	68	60	51	43	34	32	26	-	-	-	-	-	-	-	-	-	-	-	-	-	-	-	-	-	-	-	-	-	-	-	-	
160		air flow rate: 60 l/s								air flow rate: 120 l/s								air flow rate: 180 l/s								air flow rate: 240 l/s								air flow rate: 300 l/s							
	500	68	67	64	59	55	53	52	51	72	71	68	62	59	55	54	53	78	77	74	67	63	60	59	58	84	84	80	72	68	65	65	65	89	89	85	77	73	69	69	69
	300	63	62	59	55	52	49	46	45	67	66	64	58	55	52	49	48	75	75	71	65	61	58	54	54	81	81	78	70	67	63	59	59	87	87	83	76	72	68	64	64
	200	58	56	50	48	42	40	40	38	65	62	56	53	47	44	44	46	73	69	63	59	53	50	50	84	80	77	69	66	58	55	55	-	-	-	-	-	-	-	-	
	100	59	54	50	45	40	35	33	31	70	64	60	53	48	42	39	38	77	73	69	61	54	48	45	44	-	-	-	-	-	-	-	-	-	-	-	-	-	-	-	-
50	54	50	46	37	33	29	25	25	69	64	58	48	42	37	32	32	-	-	-	-	-	-	-	-	-	-	-	-	-	-	-	-	-	-	-	-	-	-	-	-	
200		air flow rate: 100 l/s								air flow rate: 200 l/s								air flow rate: 300 l/s								air flow rate: 400 l/s								air flow rate: 450 l/s							
	500	70	64	61	55	52	52	55	55	75	68	65	59	55	55	59	59	83	76	72	65	61	61	65	65	90	82	78	72	67	66	71	70	93	85	81	73	71	70	74	73
	300	67	62	56	50	48	45	48	48	74	68	62	55	52	51	53	52	84	78	71	64	61	57	60	60	92	84	78	71	67	63	67	66	95	87	81	72	68	66	69	68
	200	62	57	55	47	44	42	42	42	71	65	62	53	50	48	47	47	83	76	71	62	58	55	54	54	90	83	79	69	65	62	61	60	-	-	-	-	-	-	-	-
	100	57	52	48	41	39	36	34	34	69	64	58	50	47	44	42	42	83	76	69	59	56	53	50	50	-	-	-	-	-	-	-	-	-	-	-	-	-	-	-	-
50	51	45	41	36	32	28	28	63	56	51	44	39	39	34	34	-	-	-	-	-	-	-	-	-	-	-	-	-	-	-	-	-	-	-	-	-	-	-	-		
250		air flow rate: 150 l/s								air flow rate: 300 l/s								air flow rate: 450 l/s								air flow rate: 600 l/s								air flow rate: 750 l/s							
	500	69	66	59	53	50	54	53	52	71	67	61	56	53	56	55	54	78	75	68	61	58	61	60	59	87	83	76	68	64	68	68	68	94	90	82	74	70	74	74	74
	300	63	61	55	50	47	46	48	47	66	63	57	51	48	47	51	48	75	72	65	59	55	55	59	55	84	80	73	67	65	64	62	61	91	87	80	72	70	69	72	68
	200	59	57	52	46	44	41	44	44	63	60	55	49	46	44	46	46	72	69	63	57	55	54	54	53	82	79	72	64	63	63	62	61	-	-	-	-	-	-	-	-
	100	56	52	45	41	38	36	34	31	63	57	51	45	43	40	38	35	75	69	60	56	52	49	45	42	-	-	-	-	-	-	-	-	-	-	-	-	-	-	-	-
50	52	48	40	38	34	32	30	24	61	56	47	45	40	38	33	28	-	-	-	-	-	-	-	-	-	-	-	-	-	-	-	-	-	-	-	-	-	-	-	-	
315		air flow rate: 250 l/s								air flow rate: 500 l/s								air flow rate: 750 l/s								air flow rate: 1000 l/s								air flow rate: 1200 l/s							
	500	68	65	59	53	50	50	53	50	74	71	65	58	55	55	58	55	82	78	71	64	60	60	54	60	89	85	77	69	68	67	69	65	92	88	80	72	71	70	72	68
	300	62	59	54	49	46	45	49	43	69	66	60	54	51	51	54	48	78	74	68	61	57	57	61	54	85	81	74	66	64	64	66	59	89	85	78	70	68	68	70	62
	200	60	55	50	45	43	40	43	40	70	64	58	52	49	48	49	46	79	72	66	59	58	57	56	52	86	79	72	65	63	62	64	58	-	-	-	-	-	-	-	-
	100	54	52	45	41	38	36	36	31	66	63	55	50	47	46	44	39	76	72	64	57	54	52	50	44	-	-	-	-	-	-	-	-	-	-	-	-	-	-	-	-
50	49	49	43	38	34	32	30	24	64	64	56	49	45	42	40	32	-	-	-	-	-	-	-	-	-	-	-	-	-	-	-	-	-	-	-	-	-	-	-	-	
400		air flow rate: 400 l/s								air flow rate: 800 l/s								air flow rate: 1200 l/s								air flow rate: 1600 l/s								air flow rate: 1800 l/s							
	500	79	73	67	62	57	60	59	58	82	75	68	65	59	62	61	60	88	81	74	70	62	66	65	64	95	87	79	75	67	71	70	69	98	90	82	78	70	74	73	72
	300	72	66	60	54	51	51	51	51	77	70	64	58	56	55	54	54	84	77	70	63	62	61	60	60	91	83	76	69	67	66	65	64	94	86	79	71	70	69	68	67
	200	67	62	56	50	48	48	48	45	74	68	62	56	53	52	52	49	82	75	68	61	60	59	58	54	89	82														